



## NC7WZ14

# TinyLogic® UHS Dual Inverter with Schmitt Trigger Inputs

### Features

- Space saving SC70 6-lead package
- Ultra small MicroPak™ leadless package
- Ultra High Speed:  $t_{PD}$  3.2ns Typ. into 50pF at 5V  $V_{CC}$
- High Output Drive:  $\pm 24mA$  at 3V  $V_{CC}$
- Broad  $V_{CC}$  Operating Range; 1.65V to 5.5V
- Matches the performance of LCX when operated at 3.3V  $V_{CC}$
- Power down high impedance inputs/outputs
- Overvoltage tolerant inputs facilitate 5V to 3V translation
- Patented noise/EMI reduction circuitry implemented

### General Description

The NC7WZ14 is a dual inverter with Schmitt trigger input from Fairchild's Ultra High Speed Series of TinyLogic® in the space saving SC70 6-lead package. The device is fabricated with advanced CMOS technology to achieve ultra high speed with high output drive while maintaining low static power dissipation over a very broad  $V_{CC}$  operating range. The device is specified to operate over the 1.65V to 5.5V  $V_{CC}$  range. The inputs and outputs are high impedance when  $V_{CC}$  is 0V. Inputs tolerate voltages up to 7V independent of  $V_{CC}$  operating voltage. Schmitt trigger inputs achieve typically 1V hysteresis between the positive-going and negative-going input threshold voltage at 5V  $V_{CC}$ .

### Ordering Information

Order Number	Package Number	Product Code Top Mark	Package Description	Supplied As
NC7WZ14P6X	MAA06A	Z14	6-Lead SC70, EIAJ SC88, 1.25mm Wide	3k Units on Tape and Reel
NC7WZ14L6X	MAC06A	A9	6-Lead MicroPak, 1.0mm Wide	5k Units on Tape and Reel

Device also available in Tape and Reel. Specify by appending suffix letter "X" to the ordering number.

 All packages are lead free per JEDEC: J-STD-020B standard.



## Connection Diagram

Pin Assignments for SC70

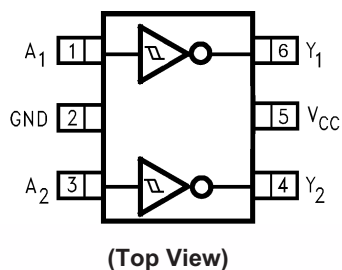

(Top View)

Pin One Orientation Diagram

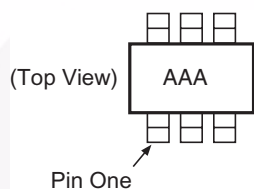

AAA represents Product Code Top Mark – see ordering code

**Note:** Orientation of Top Mark determines Pin One location. Read the top product code mark left to right, Pin One is the lower left pin (see diagram).

Pad Assignments for MicroPak

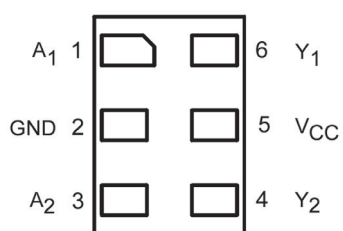

(Top Thru View)

## Logic Symbol

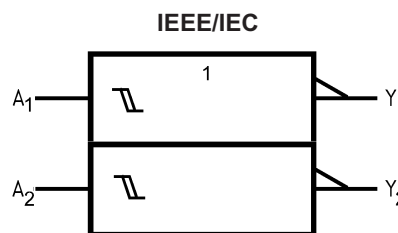

## Function Table

$$Y = \bar{A}$$

Input	Output
A	Y
L	H
H	L

H = HIGH Logic Level

L = LOW Logic Level

## Pin Description

Pin Names	Description
A <sub>1</sub> , A <sub>2</sub>	Data Inputs
Y <sub>1</sub> , Y <sub>2</sub>	Output

## Absolute Maximum Ratings

Stresses exceeding the absolute maximum ratings may damage the device. The device may not function or be operable above the recommended operating conditions and stressing the parts to these levels is not recommended. In addition, extended exposure to stresses above the recommended operating conditions may affect device reliability. The absolute maximum ratings are stress ratings only.

Symbol	Parameter	Rating
$V_{CC}$	Supply Voltage	-0.5V to +7V
$V_{IN}$	DC Input Voltage	-0.5V to +7V
$V_{OUT}$	DC Output Voltage	-0.5V to +7V
$I_{IK}$	DC Input Diode Current @ $V_{IN} < -0.5V$	-50mA
$I_{OK}$	DC Output Diode Current @ $V_{OUT} < -0.5V$	-50mA
$I_{OUT}$	DC Output Current	$\pm 100mA$
$I_{CC}/I_{GND}$	DC $V_{CC}/GND$ Current	$\pm 50mA$
$T_{STG}$	Storage Temperature	-65°C to +150°C
$T_J$	Junction Temperature Under Bias	150°C
$T_L$	Junction Lead Temperature (Soldering, 10 seconds)	260°C
$P_D$	Power Dissipation @ +85°C	180mW

## Recommended Operating Conditions<sup>(1)</sup>

The Recommended Operating Conditions table defines the conditions for actual device operation. Recommended operating conditions are specified to ensure optimal performance to the datasheet specifications. Fairchild does not recommend exceeding them or designing to absolute maximum ratings.

Symbol	Parameter	Rating
$V_{CC}$	Supply Voltage Operating	1.65V to 5.5V
	Supply Voltage Data Retention	1.5V to 5.5V
$V_{IN}$	Input Voltage	0V to 5.5V
$V_{OUT}$	Output Voltage	0V to $V_{CC}$
$T_A$	Operating Temperature	-40°C to +85°C
$\theta_{JA}$	Thermal Resistance	350°C/W

### Note:

1. Unused inputs must be held HIGH or LOW. They may not float.

### DC Electrical Characteristics

Symbol	Parameter	V <sub>CC</sub> (V)	Conditions		T <sub>A</sub> = +25°C			T <sub>A</sub> = -40°C to +85°C		Units						
					Min.	Typ.	Max.	Min.	Max.							
V <sub>P</sub>	Positive Threshold Voltage	1.65			0.6		1.4	0.6	1.4	V						
		1.8			0.7		1.5	0.7	1.5							
		2.3			1.0		1.8	1.0	1.8							
		3.0			1.3		2.2	1.3	2.2							
		4.5			1.9		3.1	1.9	3.1							
		5.5			2.2		3.6	2.2	3.6							
V <sub>N</sub>	Negative Threshold Voltage	1.65			0.2	0.5	0.8	0.2	0.8	V						
		1.8			0.25	0.56	0.9	0.25	0.9							
		2.3			0.40	0.75	1.15	0.40	1.15							
		3.0			0.6	0.98	1.5	0.6	1.5							
		4.5			1.0	1.42	2.0	1.0	2.0							
		5.5			1.2	1.68	2.3	1.2	2.3							
V <sub>H</sub>	Hysteresis Voltage	1.65			0.1	0.48	0.9	0.1	0.9	V						
		1.8			0.15	0.51	1.0	0.15	1.0							
		2.3			0.25	0.62	1.1	0.25	1.1							
		3.0			0.4	0.76	1.2	0.4	1.2							
		4.5			0.6	1.01	1.5	0.6	1.5							
		5.5			0.7	1.20	1.7	0.7	1.7							
V <sub>OH</sub>	HIGH Level Output Voltage	1.65	V <sub>IN</sub> = V <sub>IL</sub>	I <sub>OH</sub> = -100μA	1.55	1.65		1.55		V						
		1.8			1.7	1.8		1.7								
		2.3			2.2	2.3		2.2								
		3.0			2.9	3.0		2.9								
		4.5			4.4	4.5		4.4								
		1.65		I <sub>OH</sub> = -4mA	1.29	1.52		1.29								
		2.3				I <sub>OH</sub> = -8mA	1.9	2.14			1.9					
		3.0						I <sub>OH</sub> = -16mA	2.4		2.75		2.4			
		3.0									I <sub>OH</sub> = -24mA	2.3	2.62		2.3	
		4.5											I <sub>OH</sub> = -32mA	3.8	4.13	
V <sub>OL</sub>	LOW Level Output Voltage	1.65	V <sub>IN</sub> = V <sub>IH</sub>	I <sub>OL</sub> = 100μA		0.0	0.1		0.1	V						
		1.8				0.0	0.1		0.1							
		2.3				0.0	0.1		0.1							
		3.0				0.0	0.1		0.1							
		4.5				0.0	0.1		0.1							
		1.65		I <sub>OL</sub> = 4mA		0.08	0.24		0.24							
		2.3				I <sub>OL</sub> = 8mA		0.10	0.3			0.3				
		3.0						I <sub>OL</sub> = 16mA			0.16	0.4		0.4		
		3.0									I <sub>OL</sub> = 24mA		0.24	0.55		0.55
		4.5											I <sub>OL</sub> = 32mA		0.25	0.55
I <sub>IN</sub>	Input Leakage Current	0 to 5.5	V <sub>IN</sub> = 5.5V, GND				±0.1	±1.0	μA							
I <sub>OFF</sub>	Power Off Leakage Current	0.0	V <sub>IN</sub> or V <sub>OUT</sub> = 5.5V				1	10	μA							
I <sub>CC</sub>	Quiescent Supply Current	1.65 to 5.5	V <sub>IN</sub> = 5.5V, GND				1.0	10	μA							

## AC Electrical Characteristics

Symbol	Parameter	V <sub>CC</sub> (V)	Conditions	T <sub>A</sub> = +25°C			T <sub>A</sub> = -40°C to +85°C		Units	Fig. No.
				Min.	Typ.	Max.	Min.	Max.		
t <sub>PLH</sub> , t <sub>PHL</sub>	Propagation Delay	1.65	C <sub>L</sub> = 15pF, R <sub>L</sub> = 1 MΩ	2.5	7.6	13.1	2.5	14.5	ns	Figure 1 Figure 3
		1.8		2.5	6.3	10.9	2.5	12		
		2.5 ± 0.2		1.8	4.3	7.4	1.8	8.1		
		3.3 ± 0.3		1.5	3.3	5.0	1.5	5.5		
		5.0 ± 0.5		1.0	2.7	4.1	1.0	4.5		
t <sub>PLH</sub> , t <sub>PHL</sub>	Propagation Delay	3.3 ± 0.3	C <sub>L</sub> = 50pF, R <sub>L</sub> = 500Ω	1.8	4.0	6.0	1.8	6.6	ns	Figure 1 Figure 3
		5.0 ± 0.5		1.2	3.2	4.9	1.2	5.4		
C <sub>IN</sub>	Input Capacitance	0			2.5				pF	
C <sub>PD</sub>	Power Dissipation Capacitance	3.3	(2)		11				pF	Figure 2
		5.0			12.5					

**Note:**

2. C<sub>PD</sub> is defined as the value of the internal equivalent capacitance which is derived from dynamic operating current consumption (I<sub>CCD</sub>) at no output loading and operating at 50% duty cycle. (See Figure 2.) C<sub>PD</sub> is related to I<sub>CCD</sub> dynamic operating current by the expression: I<sub>CCD</sub> = (C<sub>PD</sub>)(V<sub>CC</sub>)(f<sub>IN</sub>) + (I<sub>CC</sub>static).

## AC Loading and Waveforms

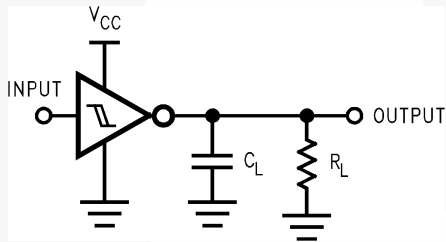

C<sub>L</sub> includes load and stray capacitance  
Input PRR = 1.0MHz; t<sub>w</sub> = 500ns

**Figure 1. AC Test Circuit**

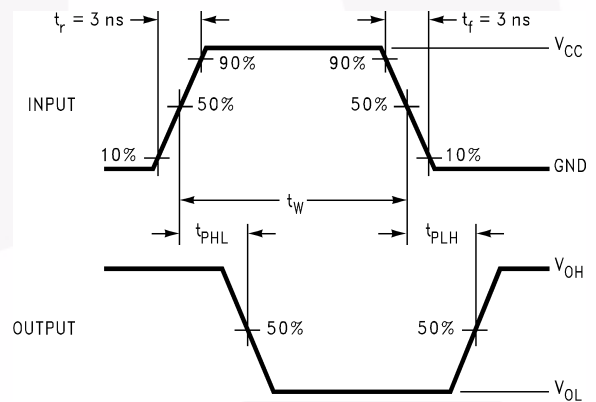

**Figure 3. AC Waveforms**

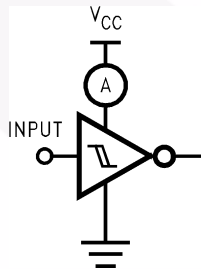

Input = AC Waveform; t<sub>r</sub> = t<sub>f</sub> = 1.8ns;  
PRR = variable; Duty Cycle = 50%

**Figure 2. I<sub>CCD</sub> Test Circuit**

## Tape and Reel Specification

### Tape Format for SC70

Package Designator	Tape Section	Number of Cavities	Cavity Status	Cover Tape Status
P6X	Leader (Start End)	125 (typ)	Empty	Sealed
	Carrier	3000	Filled	Sealed
	Trailer (Hub End)	75 (typ)	Empty	Sealed

### Tape Dimensions inches (millimeters)

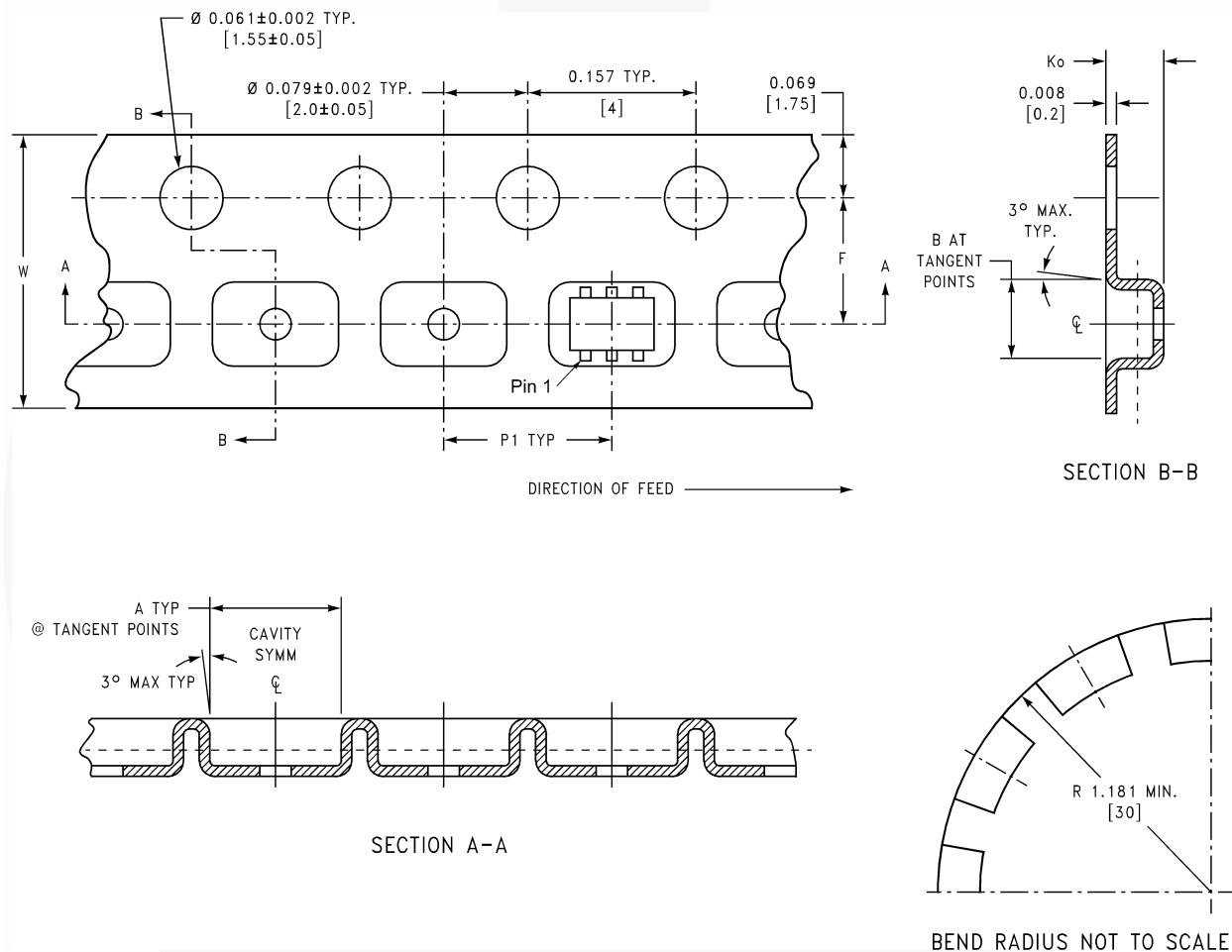

Package	Tape Size	Dim A	Dim B	Dim F	Dim K <sub>o</sub>	Dim P1	Dim W
SC70-6	8mm	0.093 (2.35)	0.096 (2.45)	0.138 ± 0.004 (3.5 ± 0.10)	0.053 ± 0.004 (1.35 ± 0.10)	0.157 (4)	0.315 ± 0.004 (8 ± 0.1)

## Tape and Reel Specifications

### Tape Format for MicroPak

Package Designator	Tape Section	Number of Cavities	Cavity Status	Cover Tape Status
L6X	Leader (Start End)	125 (typ.)	Empty	Sealed
	Carrier	5000	Filled	Sealed
	Trailer (Hub End)	75 (typ.)	Empty	Sealed

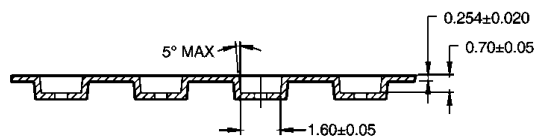
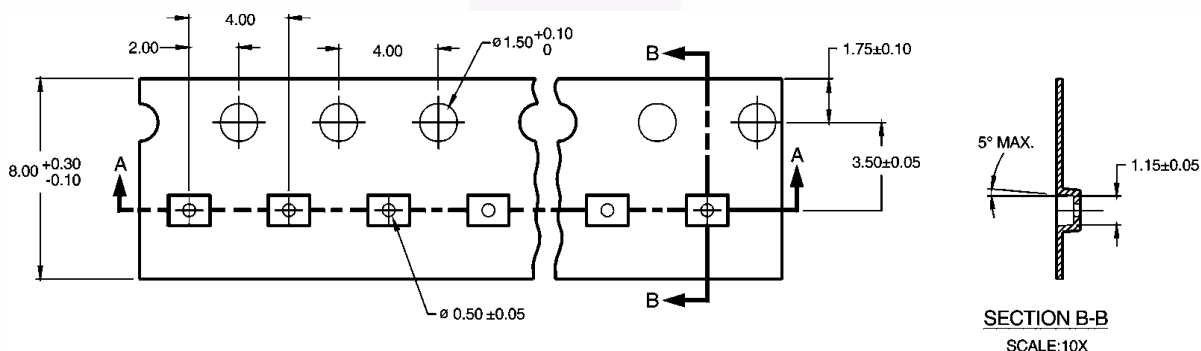

**SECTION A-A**  
SCALE:10X

### Reel Dimensions inches (millimeters)

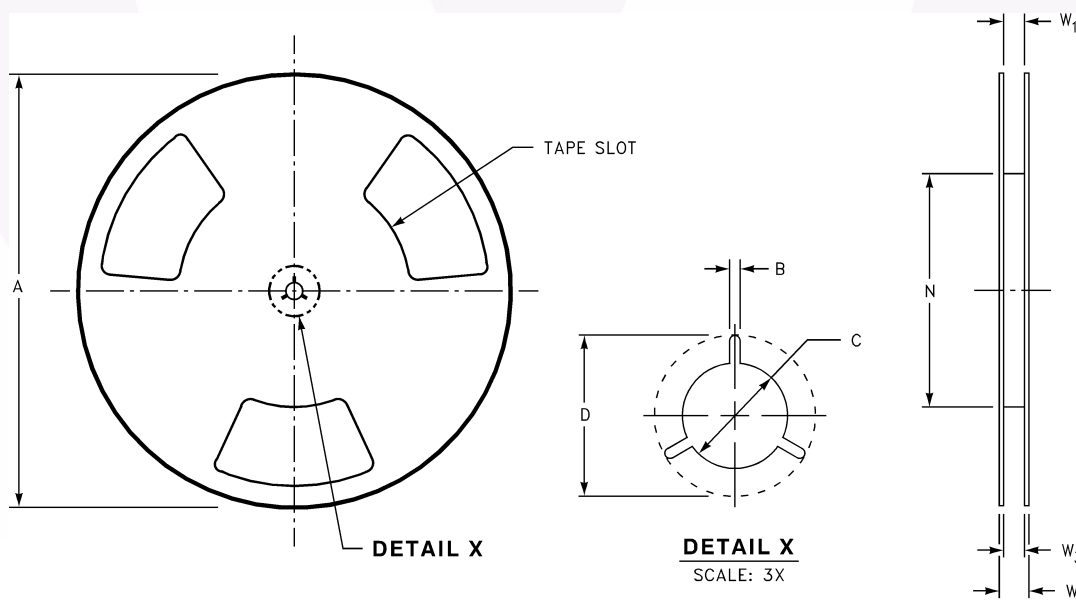

Tape Size	A	B	C	D	N	W1	W2	W3
8mm	7.0 (177.8)	0.059 (1.50)	0.512 (13.00)	0.795 (20.20)	2.165 (55.00)	0.331 + 0.059/-0.000 (8.40 + 1.50/-0.00)	0.567 (14.40)	W1 + 0.078/-0.039 (W1 + 2.00/-1.00)

## Physical Dimensions

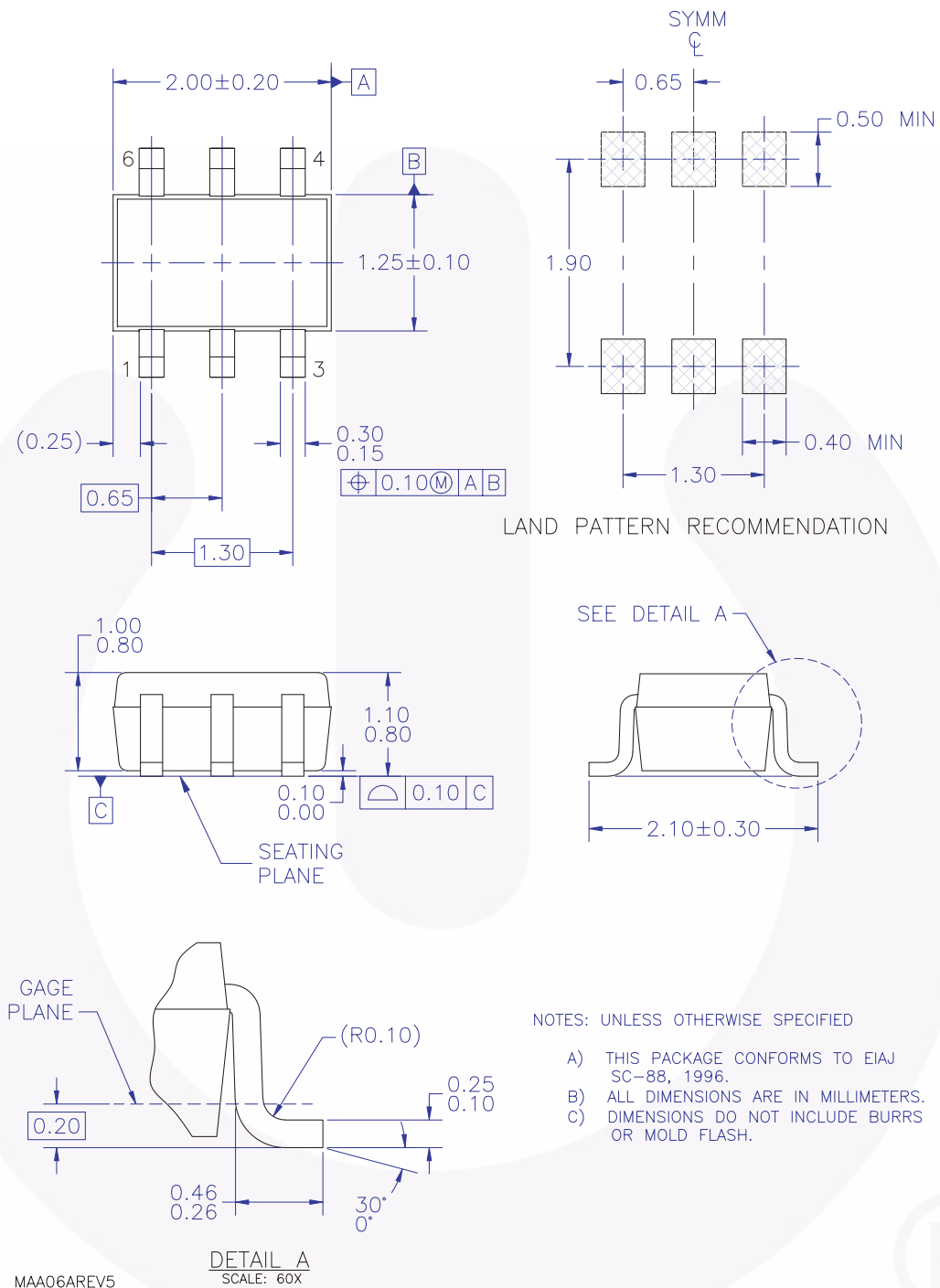

**Figure 4. 6-Lead SC70, EIAJ SC88, 1.25mm Wide**

Package drawings are provided as a service to customers considering Fairchild components. Drawings may change in any manner without notice. Please note the revision and/or date on the drawing and contact a Fairchild Semiconductor representative to verify or obtain the most recent revision. Package specifications do not expand the terms of Fairchild's worldwide terms and conditions, specifically the warranty therein, which covers Fairchild products.

Always visit Fairchild Semiconductor's online packaging area for the most recent package drawings:  
<http://www.fairchildsemi.com/packaging/>



**Physical Dimensions** (Continued)

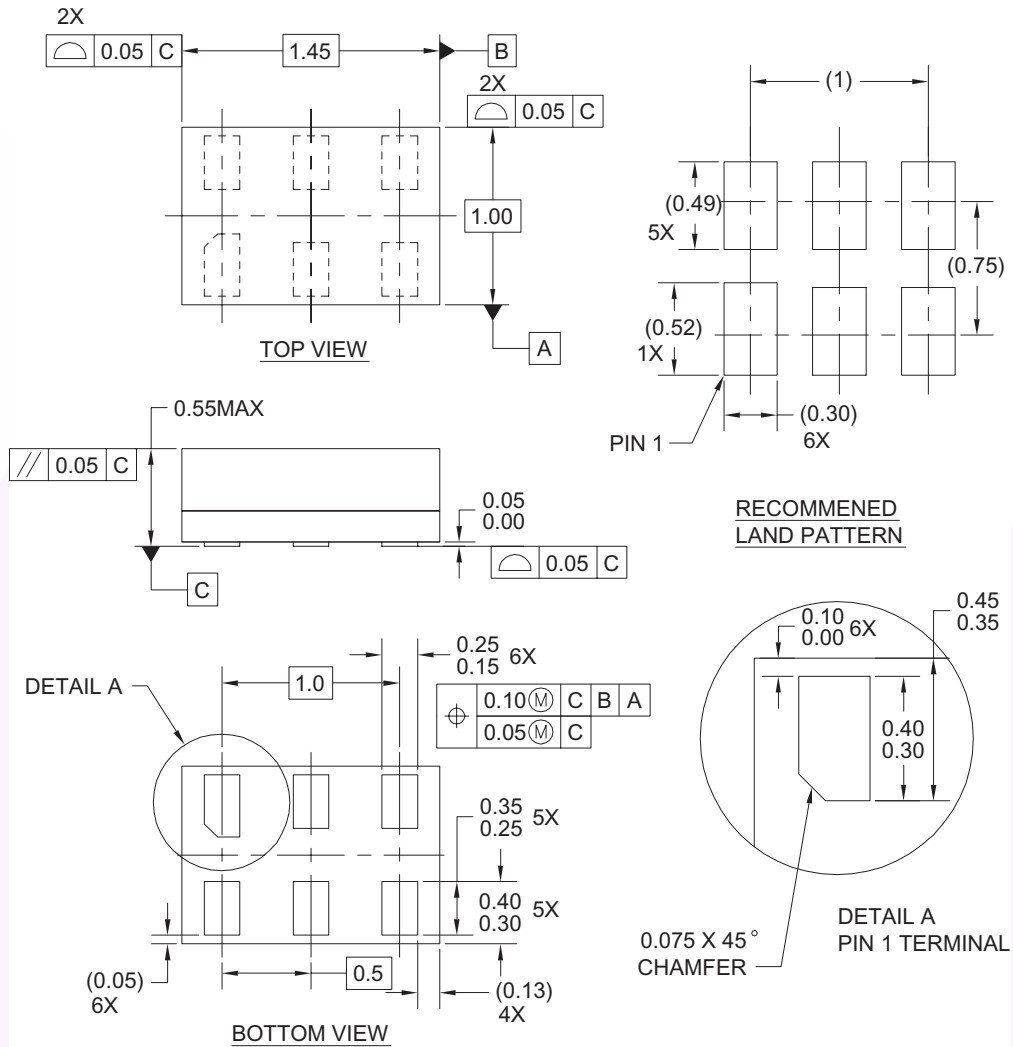

**Notes:**

1. CONFORMS TO JEDEC STANDARD M0-252 VARIATION UAAD
2. DIMENSIONS ARE IN MILLIMETERS
3. DRAWING CONFORMS TO ASME Y14.5M-1994

MAC06AREVC

**Figure 5. 6-Lead MicroPak, 1.0mm Wide**

Package drawings are provided as a service to customers considering Fairchild components. Drawings may change in any manner without notice. Please note the revision and/or date on the drawing and contact a Fairchild Semiconductor representative to verify or obtain the most recent revision. Package specifications do not expand the terms of Fairchild's worldwide terms and conditions, specifically the warranty therein, which covers Fairchild products.

Always visit Fairchild Semiconductor's online packaging area for the most recent package drawings:

<http://www.fairchildsemi.com/packaging/>



**TRADEMARKS**

The following includes registered and unregistered trademarks and service marks, owned by Fairchild Semiconductor and/or its global subsidiaries, and is not intended to be an exhaustive list of all such trademarks.

- |   |  |  |                                  |
|---|--|--|----------------------------------|
| ACEx <sup>®</sup>   | FPS <sup>™</sup>                             | PDP-SPM <sup>™</sup>                   | SupreMOS <sup>™</sup>            |
| Build it Now <sup>™</sup>   | FRFET <sup>®</sup>                           | Power220 <sup>®</sup>                  | SyncFET <sup>™</sup>             |
| CorePLUS <sup>™</sup>   | Global Power Resource <sup>SM</sup>          | POWEREDGE <sup>®</sup>                 | SYSTEM <sup>®</sup>              |
| CROSSVOLT <sup>™</sup>  | Green FPS <sup>™</sup>                       | Power-SPM <sup>™</sup>                 | GENERAL <sup>®</sup>             |
| CTL <sup>™</sup>  | Green FPS <sup>™</sup> e-Series <sup>™</sup> | PowerTrench <sup>®</sup>               | The Power Franchise <sup>®</sup> |
| Current Transfer Logic <sup>™</sup>   | GTO <sup>™</sup>                             | Programmable Active Droop <sup>™</sup> | <b>power</b> <sup>®</sup>        |
| EcoSPARK <sup>®</sup>   | i-Lo <sup>™</sup>                            | QFET <sup>®</sup>                      | the                              |
| EZSWITCH <sup>™</sup> *   | IntelliMAX <sup>™</sup>                      | QS <sup>™</sup>                        | franchise                        |
|  | ISOPLANAR <sup>™</sup>                       | QT Optoelectronics <sup>™</sup>        | TinyBoost <sup>™</sup>           |
|  | MegaBuck <sup>™</sup>                        | Quiet Series <sup>™</sup>              | TinyBuck <sup>™</sup>            |
| Fairchild <sup>®</sup>  | MICROCOUPLER <sup>™</sup>                    | RapidConfigure <sup>™</sup>            | TinyLogic <sup>®</sup>           |
| Fairchild Semiconductor <sup>®</sup>  | MicroFET <sup>™</sup>                        | SMART START <sup>™</sup>               | TINYOPTO <sup>™</sup>            |
| FACT Quiet Series <sup>™</sup>  | MicroPak <sup>™</sup>                        | SPM <sup>®</sup>                       | TinyPower <sup>™</sup>           |
| FACT <sup>®</sup>   | MillerDrive <sup>™</sup>                     | STEALTH <sup>™</sup>                   | TinyPWM <sup>™</sup>             |
| FAST <sup>®</sup>   | Motion-SPM <sup>™</sup>                      | SuperFET <sup>™</sup>                  | TinyWire <sup>™</sup>            |
| FastvCore <sup>™</sup>  | OPTOLOGIC <sup>®</sup>                       | SuperSOT <sup>™</sup> 3                | µSerDes <sup>™</sup>             |
| FlashWriter <sup>®</sup> *  | OPTOPLANAR <sup>®</sup>                      | SuperSOT <sup>™</sup> 6                | UHC <sup>®</sup>                 |
|   |  | SuperSOT <sup>™</sup> 8                | Ultra FRFET <sup>™</sup>         |
|   |  |  | UniFET <sup>™</sup>              |
|   |  |  | VCX <sup>™</sup>                 |

\* EZSWITCH<sup>™</sup> and FlashWriter<sup>®</sup> are trademarks of System General Corporation, used under license by Fairchild Semiconductor.

**DISCLAIMER**

FAIRCHILD SEMICONDUCTOR RESERVES THE RIGHT TO MAKE CHANGES WITHOUT FURTHER NOTICE TO ANY PRODUCTS HEREIN TO IMPROVE RELIABILITY, FUNCTION, OR DESIGN. FAIRCHILD DOES NOT ASSUME ANY LIABILITY ARISING OUT OF THE APPLICATION OR USE OF ANY PRODUCT OR CIRCUIT DESCRIBED HEREIN; NEITHER DOES IT CONVEY ANY LICENSE UNDER ITS PATENT RIGHTS, NOR THE RIGHTS OF OTHERS. THESE SPECIFICATIONS DO NOT EXPAND THE TERMS OF FAIRCHILD'S WORLDWIDE TERMS AND CONDITIONS, SPECIFICALLY THE WARRANTY THEREIN, WHICH COVERS THESE PRODUCTS.

**LIFE SUPPORT POLICY**

FAIRCHILD'S PRODUCTS ARE NOT AUTHORIZED FOR USE AS CRITICAL COMPONENTS IN LIFE SUPPORT DEVICES OR SYSTEMS WITHOUT THE EXPRESS WRITTEN APPROVAL OF FAIRCHILD SEMICONDUCTOR CORPORATION.

As used herein:

- Life support devices or systems are devices or systems which, (a) are intended for surgical implant into the body or (b) support or sustain life, and (c) whose failure to perform when properly used in accordance with instructions for use provided in the labeling, can be reasonably expected to result in a significant injury of the user.
- A critical component in any component of a life support, device, or system whose failure to perform can be reasonably expected to cause the failure of the life support device or system, or to affect its safety or effectiveness.

**PRODUCT STATUS DEFINITIONS**

**Definition of Terms**

Datasheet Identification	Product Status	Definition
Advance Information	Formative or In Design	This datasheet contains the design specifications for product development. Specifications may change in any manner without notice.
Preliminary	First Production	This datasheet contains preliminary data; supplementary data will be published at a later date. Fairchild Semiconductor reserves the right to make changes at any time without notice to improve design.
No Identification Needed	Full Production	This datasheet contains final specifications. Fairchild Semiconductor reserves the right to make changes at any time without notice to improve the design.
Obsolete	Not In Production	This datasheet contains specifications on a product that has been discontinued by Fairchild Semiconductor. The datasheet is printed for reference information only.

Rev. I33